

Over Speed Governor

Top Pulley 200mm

(Machine Roomless)

The **Quality** Inspires Trust

Machine Roomless BI Directional

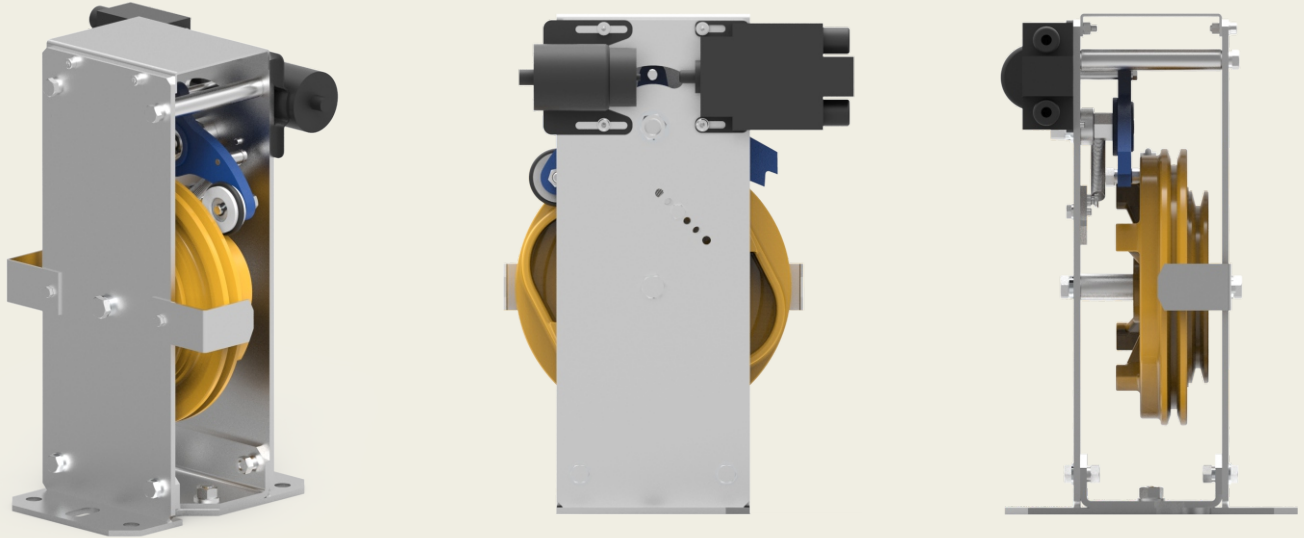

Technical Drawing

Technical Specification

OSGTP200MRL	Bi Directional for Machine Roomless
Nominal Speed	0.32 – 1.50 m/s
Tripping Speed	0.40 – 1.88 m/s
Ø Rope	6 & 8 mm

Available with Limit switch, Test Groove & Remote Control for Machine Roomless Operation

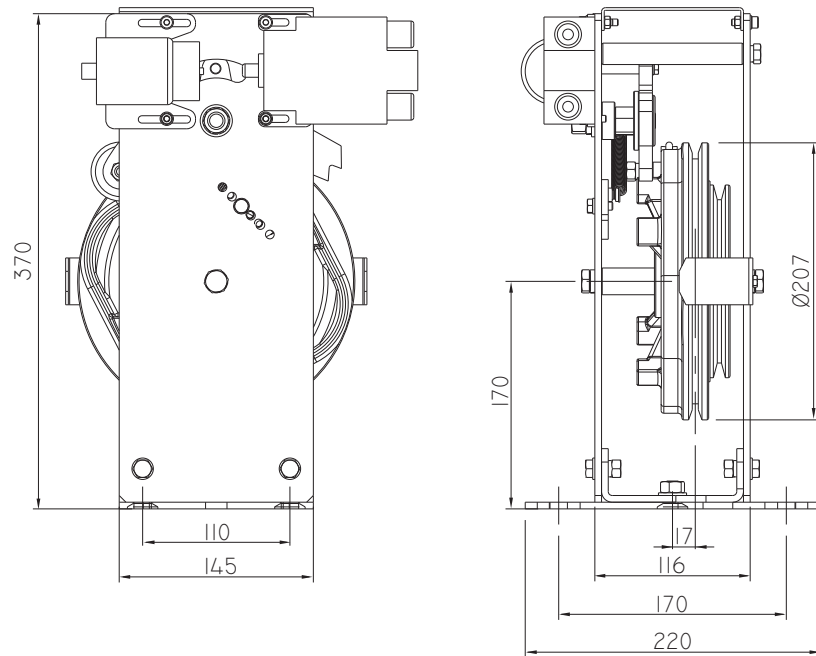

All dimensions are in mm.