

6 5 4 3 2 1

E  
D  
C  
B  
A

ALL DIMENSION ARE IN MM UNLESS OTHERWISE SPECIFIED.  
THE INFORMATION CONTAINED IN THIS DRAWING IS THE ONLY PROPERTY OF SHARP ENGINEERS  
ANY REPRODUCTION IN PART OR AS WHOLE WITHOUT THE WRITTEN PERMISSION OF SHARP  
ENGINEERS IS PROHIBITED.

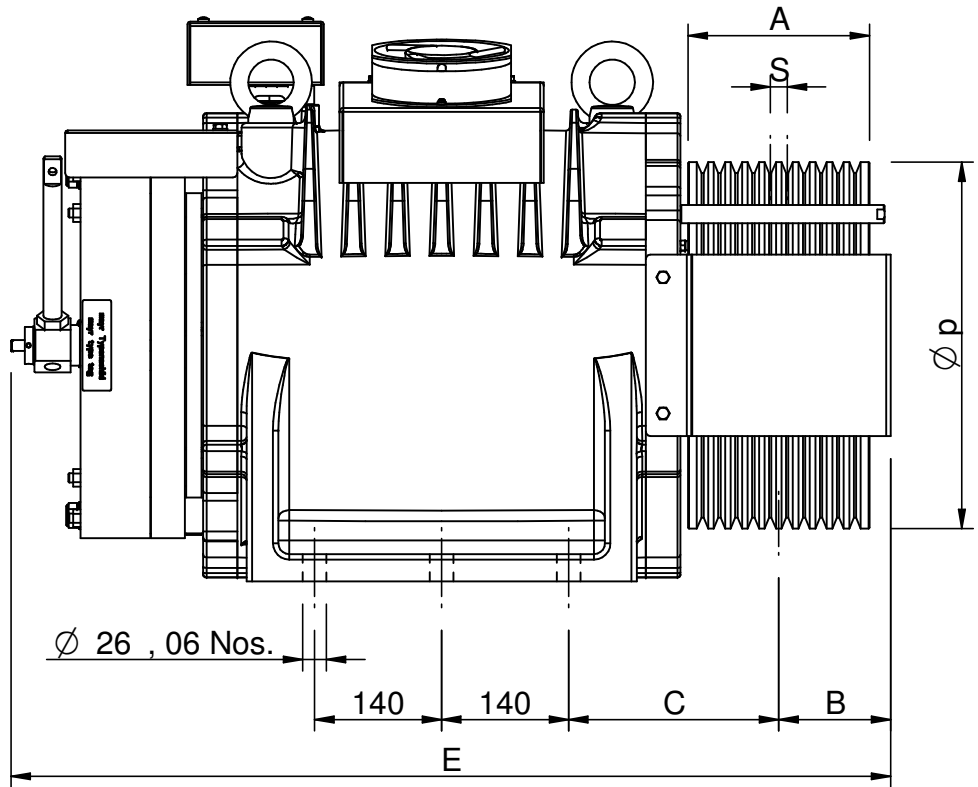
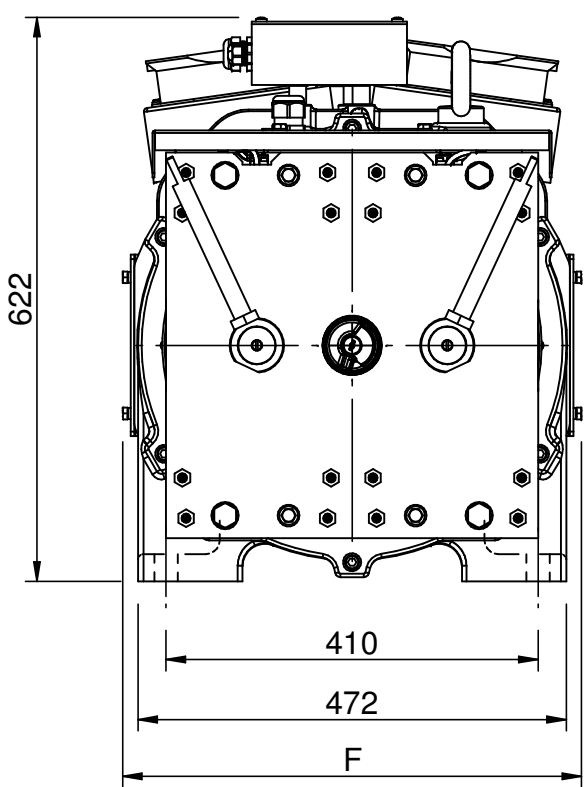

ØP	A	B	C	N X ØD	E	F	S
Ø400	200	124	232	9 X Ø10	970	510	16
				11 X Ø10			

ØP	A	B	C	N X ØD	E	F	S
Ø450	185	123	224	10 X Ø11	965	510	16

REVISION No.	DESCRIPTION	DATE	APPROVED BY	DRWN BY K M	SIZE A4	SCALE	TITLE:- SEG-70 G.A.DRAWING
6	5	4		DRWN DATE 19-06-2020			



E  
D  
C  
B  
A

6 5 4 3 2 1